



PEDRALI[®]

NEW IDEAS 2013

Mario Pedrali, fondatore
Mario Pedrali, founder

Il **Made in Italy** è la nostra essenza, da sempre.

Tradizione, innovazione, eccellenza ingegneristica e genio creativo sono i concetti che da cinquant'anni scandiscono il nostro lavoro.

L'**internazionalità** è nel nostro DNA, e lo testimoniano i 99 Paesi in cui esportiamo.

Il **Salone del Mobile** è il luogo dove ci piace confrontarci.

Il **Premio Compasso d'Oro ADI**, l'emozione più intensa.

I **nostri clienti**, la nostra forza.

Made in Italy is our essence, since ever.

Tradition, innovation, know-how excellence and creativity are the values that have been driving our work for fifty years.

Our DNA is international, witnessed by the 99 Countries where we export.

Salone del Mobile is the place where we like to meet the world.

The Compasso d'Oro ADI Award, our most intense emotion.

Our customers, our strength.

VOLT

INJECTION OF DYNAMISM

Claudio Dondoli - Marco Pucci

"Una nuova visione che esprime l'essenzialità elegante dell'oggi. Il suo tratto sottile e lineare, le sue gradevoli proporzioni ed i colori freschi rendono Volt una seduta che si distingue per la cura dei dettagli".

"A new concept that expresses the smart simplicity of everyday's lifestyle. The thin and linear design, the graceful proportions and the fresh colours make Volt a seating that stands out for its care for details".



pannello frontale imbottito
upholstered front panel

SCHEMA TECNICA

Materiali e tecnologie: polipropilene rinforzato con fibre di vetro e stampato ad iniezione con gas air moulding.
Colori: bianco, nero, rosso, grigio antracite, beige, giallo, blu.
Varianti: sedia e poltrona disponibili con pannello frontale imbottito.

TECHNICAL FEATURES

Materials and Technologies: injection gas air moulding polypropylene reinforced by glass fibers.
Colours: white, black, red, anthracite grey, beige, yellow, blue.
Options: chair and armchair available with upholstered front panel.

Art. 670

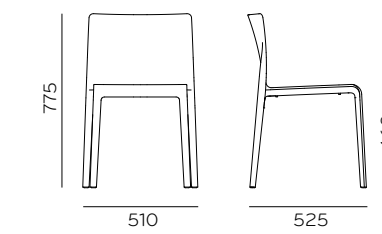

Art. 675

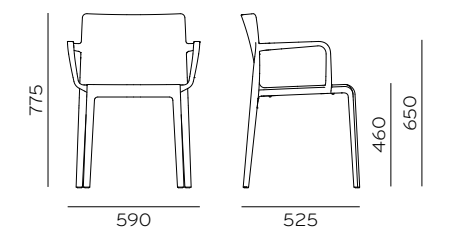

Art. 671

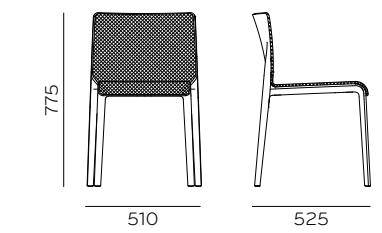

Art. 676

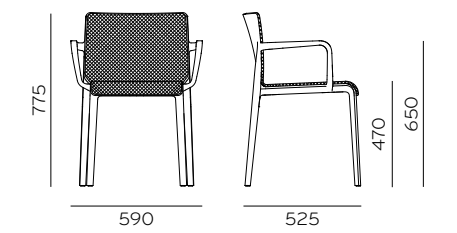

finitura opaca
matt finish



100% riciclabile
100% recyclable



indoor & outdoor

impilabile
stackable



bracciolo ergonomico
ergonomic armrest



ESTER

L'ELEGANCE DE PREMIERE CLASSE

Patrick Jouin

"Il design di questa poltrona è una raccolta di tutte le informazioni che ho appreso da quando progetto ristoranti. La poltrona Ester è un mix di eleganza, ergonomia e funzionalità. L'attenzione per il dettaglio è onnipresente. Il risultato è un prezioso monolito di pelle, completato dalla raffinata gamba in pressofusione d'alluminio".

"The design of this armchair is the outcome of the experiences I achieved since I started designing restaurants. Ester armchair is a mix of elegance, ergonomics and functionality. The care for details is everywhere. The result is a precious monolith made of leather with the refined die-casted aluminum legs".

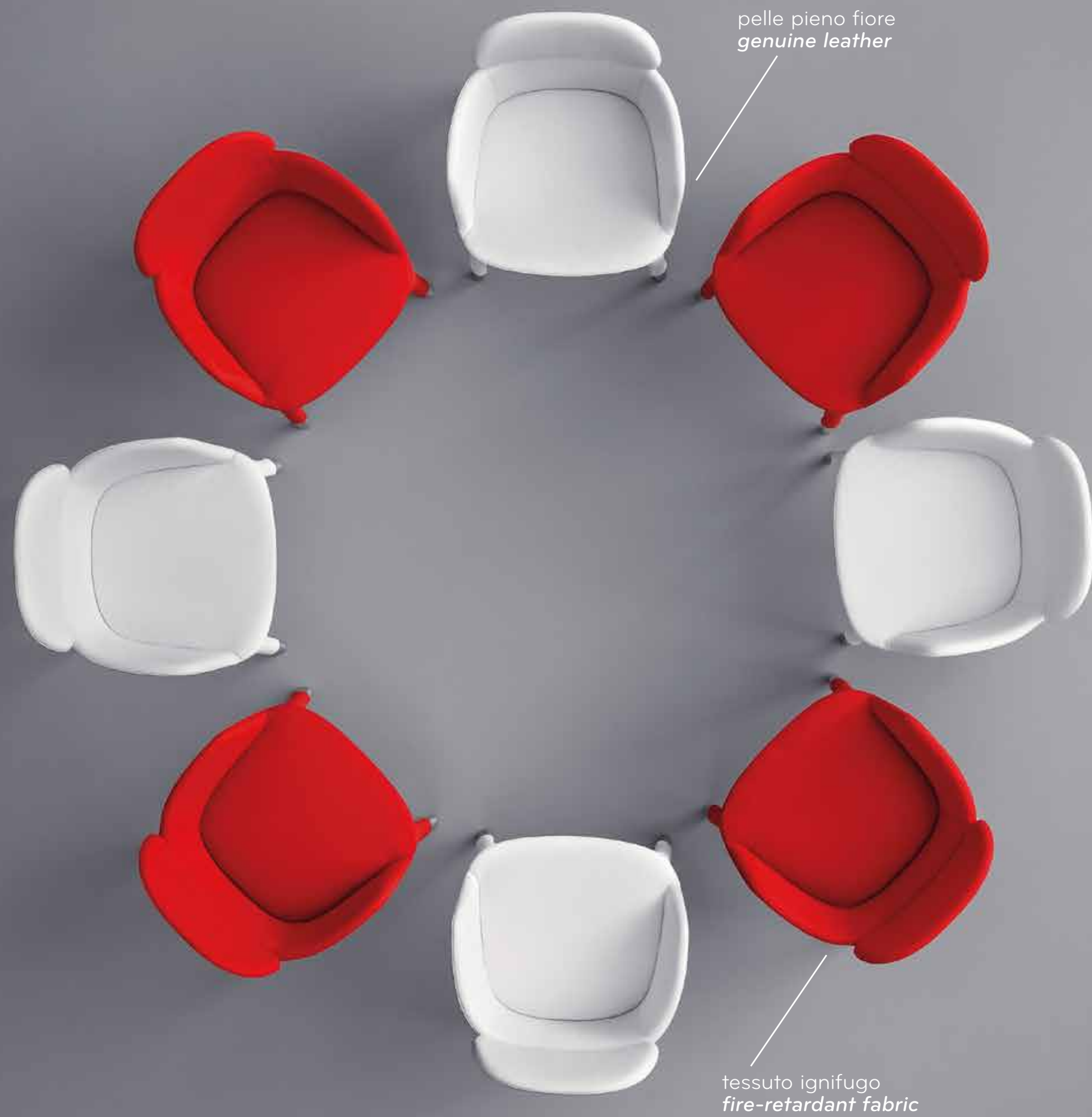

ESTER

pressofusione d'alluminio
die-casted aluminium

forme ergonomiche
ergonomic shapes



SCHEDA TECNICA

Materiali e tecnologie: seduta in schiumato poliuretano con cinghie elastiche su struttura in acciaio; gambe in pressofusione di alluminio.
Finiture: rivestimento in pelle o tessuto; gambe in alluminio satinato, bronzo satinato o nichel nero lucido.

TECHNICAL FEATURES

Materials and Technologies: steel frame with elastic belts, fire retardant injected foam, die-casted aluminium legs.

Finishes: upholstered with genuine leather or fire retardant fabric. Aluminium legs: brushed aluminium, brushed bronze or glossy black nickel finishes.

Art. 690

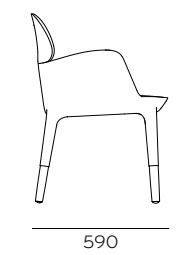
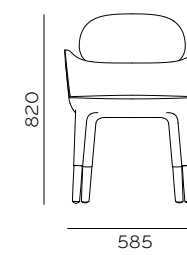

Art. 691

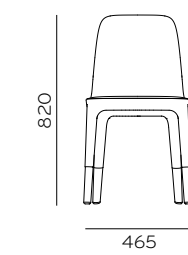

anima in schiumato poliuretano
injected foam core



cinghie elastiche
elastic belts



BRICK

PLAY WITH COLOURS

Pio e Tito Toso

"Abbiamo pensato ad un portaombrelli che fosse caratterizzato da un volume puro e che avesse il compito di contenere con ordine, occupando il minor spazio possibile. Brick è un oggetto pratico per i giorni piovosi, un modulo d'arredo per tutte le altre giornate dell'anno".

"We have designed an umbrella stand, featured by a pure volume, for a tidy storage in the smallest possible space. Brick is a practical object for rainy days as well as a modular piece of furniture for all the other days of the year."

modulare e impilabile
modular and stackable

portaombrelli e parete divisoria
umbrella stand and space divider



finitura opaca antigraffio
matt and scratch resistant finish



dieci fori, contiene fino a 20 ombrelli
ten holes, storing up to 20 umbrellas

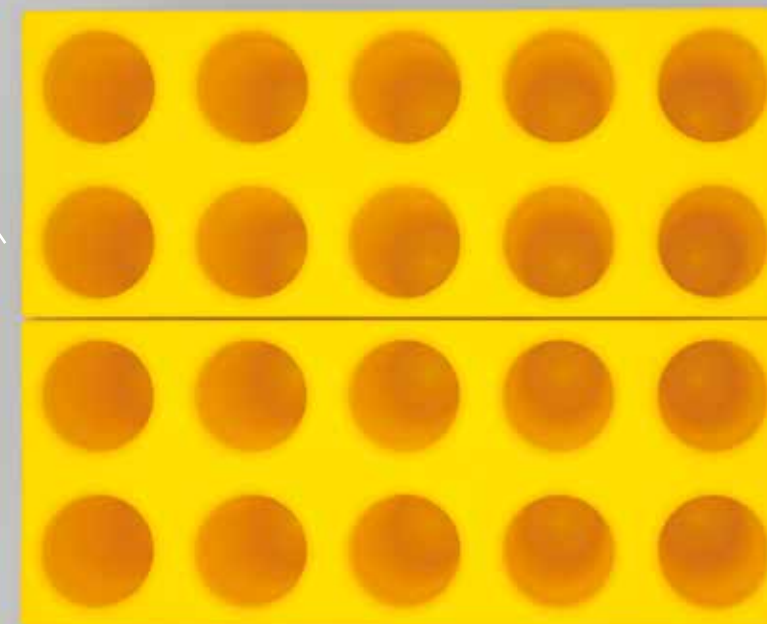

polietilene
polyethylene



SCHEDA TECNICA

Materiali e tecnologie: polietilene stampato rotazionale.
Finiture: opaca antigraffio.
Colori: bianco, grigio chiaro, arancio, blu, giallo, verde.

TECHNICAL FEATURES

Materials and Technologies: rotomoulding polyethylene.
Finishes: matt and scratch resistant.
Colours: white, light grey, orange, blue, yellow, green.

Art. BRICK

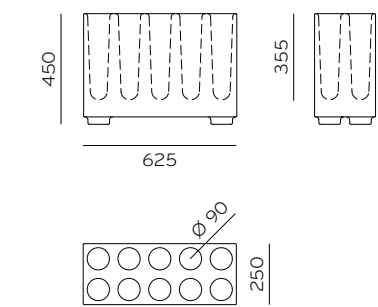

TWEET

ECLECTIC BY CHOICE

Marc Sadler

"Tweet nasce dalla volontà di creare un elemento di arredo razionale e adatto ad essere inserito anche negli ambienti più connotati, rispettandone lo stile. Elemento distintivo è l'esile scocca in polipropilene che grazie alla tecnologia di stampaggio a bi-iniezione raggiunge livelli di comfort assoluto. La parte frontale bombata e dalla finitura opaca, a contrasto con la superficie lucida del retro, ricorda infatti una morbida seduta imbottita. La cornice della parte posteriore facilita la presa e conferisce un aspetto tridimensionale".

"Tweet was conceived from the desire of creating a rational piece of furniture suitable to be placed even in the most characteristic spaces, respecting their style. A distinctive feature is the thin polypropylene shell that offers a high comfort thanks to the bi-injection moulding technology. The frontal rounded shell in matt finish, in contrast to the glossy surface of the back, evokes a soft upholstered seating. The outline of the backside shell makes the chair easy to handle and gives a three-dimensional look".

Art. 890

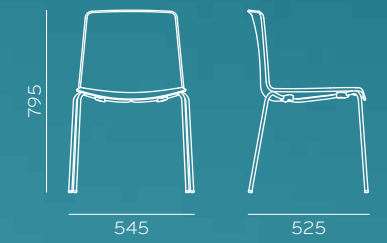

Art. 895

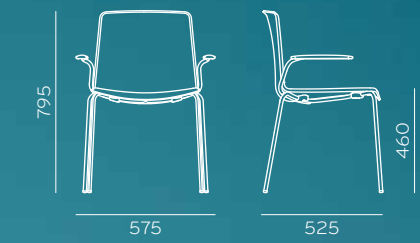

SCHEDA TECNICA

Materiali e tecnologie: scocca in polipropilene stampato a bi-iniezione, struttura in acciaio Ø 14mm.

Finiture: finitura retro lucida, finitura frontale opaca antigraffio.

Colori: monocolore disponibile bianco, nero, beige, arancio.

Bicolore con la parte frontale bianco retro a scelta tra nero, grigio, beige, giallo, rosso.

Telaio verniciato o cromato.

TECHNICAL FEATURES

Materials and Technologies: bi-injection moulded polypropylene. Steel tube frame Ø 14mm.

Finishes: glossy finish on the back of the shell, matt and scratch resistant on the front side.

Colours: one-color version in white, black, beige, orange.

Two-colours version with white front and back side in black, grey, beige, yellow or red. Frame in chrome or powder coated.

superficie posteriore polipropilene lucido
glossy polypropylene back surface

polipropilene bianco opaco
matt white polypropylene

bordo colorato come lo schienale
coloured outline matching the back side

impilabile
stackable

cornice che facilita la presa
easy-to-handle edge



ARKI-TABLE

A PERFECT BALANCE

Pedrali R&D

"Look industriale, proporzioni rigorose e versatilità nell'utilizzo. La famiglia Arki-Table si arricchisce di tre nuove versioni che mantengono il ripiano ultrasottile e le caratteristiche gambe a cavalletto".

"Industrial look, rigorous shapes and versatility. The Arki-Table family has been enriched by three new versions, that still keep the extremely thin tops and the peculiar structure with trestle legs".

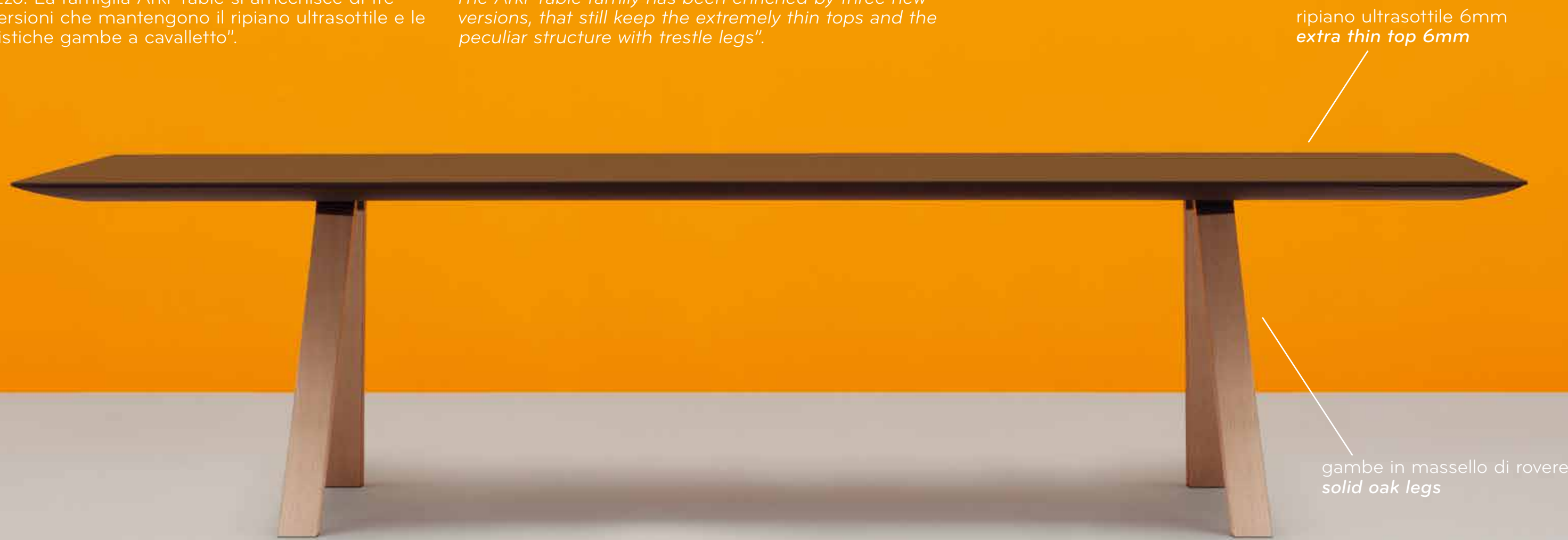

SCHEMA TECNICA

Materiali e tecnologie: gambe in acciaio verniciato oppure in massello di rovere, profilo-cornice in estruso di alluminio, ripiano in stratificato di 6mm e 12mm.
Finiture: bianco o nero.
Varioni: il tavolo rettangolare è disponibile anche con canalina passacavi.

TECHNICAL FEATURES

Materials and Technologies: powder coated steel or solid oak legs, extruded aluminium frame, solid laminate top 6mm and 12mm.
Finishes: white or black.
Options: top available with cable management for rectangular versions.

Art. ARKW200X100
ARKW240X100/120
ARKW300X100/120

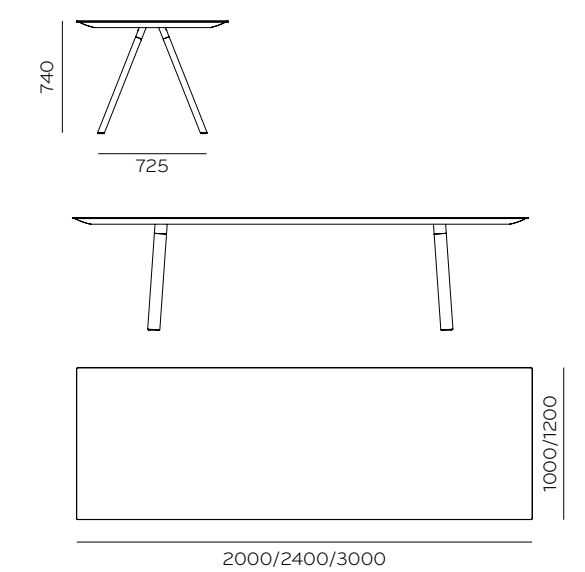

Art. ARKD139

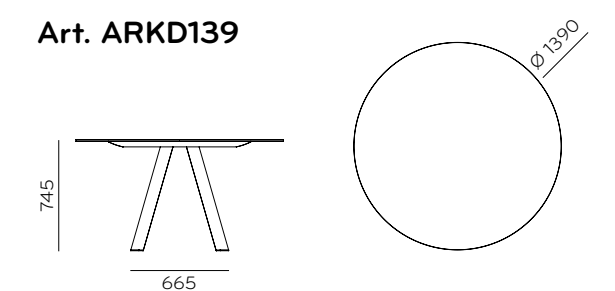

Art. ARKD159

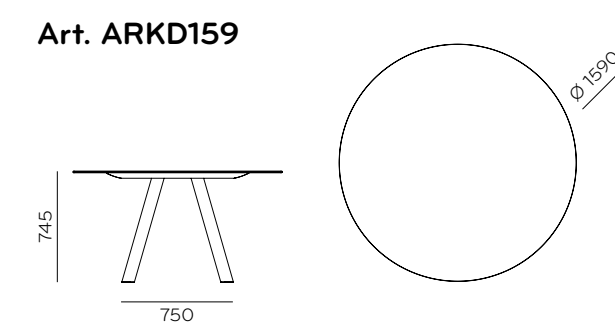

Art. ARK139X139

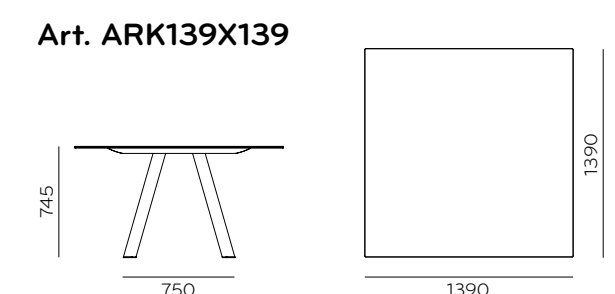

"La famiglia Malmö si estende a nuovi usi contaminando gli ambienti lounge, le sale d'attesa e le aree bar. Alla sedia e poltroncina si affiancano la poltrona lounge, i coffee tables e gli sgabelli, tutti con struttura in frassino dalle gambe tornite e affusolate, per un risultato di estrema leggerezza formale ed inconfondibile sapore scandinavo".

"Malmö family expands to new contexts such as lounge environments, waiting areas and cafes. The collection has now been enriched by a lounge armchair, coffee tables and barstools, all made of solid ash frame with tapered legs. The result is a unique Scandinavian taste of exceptional lightness".



MALMÖ

scocca imbottita
upholstered shell



SCHEDA TECNICA

Materiali e tecnologie: poltrona lounge con struttura in essenza di frassino, scocca imbottita o in multistrato impiallacciato frassino; sgabelli con struttura in essenza di frassino, scocca in multistrato impiallacciato frassino, imbottita o in cuoio; coffee tables con ripiano in mdf laccato, impiallacciato frassino o stratificato; gambe in massello di frassino tornite.
Finiture: frassino sbiancato o tinto nero.

TECHNICAL FEATURES

Materials and Technologies: lounge armchair in solid ash wood, upholstered seat version or ash veneered plywood shell; barstools in solid ash wood, ash veneered plywood shell, upholstered with fabric or genuine leather; coffee tables with lacquered mdf, ash veneered or solid laminate tops, tapered legs in ash wood.
Finishes: bleached or stained black ash wood.

ripiano in mdf laccato
lacquered mdf top



Art. 295

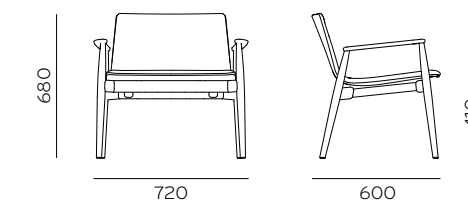

Art. 236

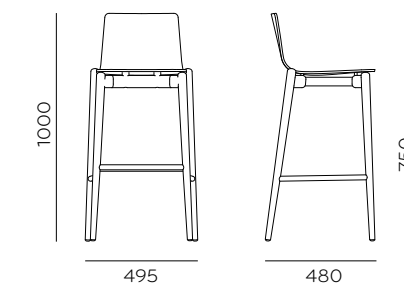

Art. 232

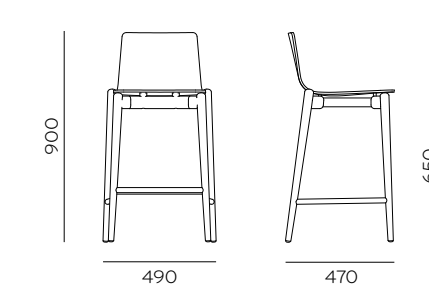

scocca impiallacciato frassino
ash veneered shell



poggiapiedi in acciaio inox
s/steel footrest



Art. MLTD100X36

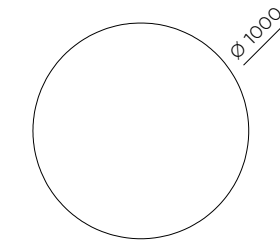
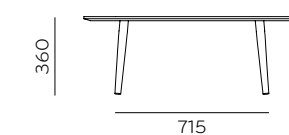

Art. MLTD60X36 Art. MLTD60X48

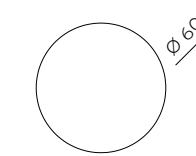

Art. MLT60X60X36 Art. MLT60X60X48

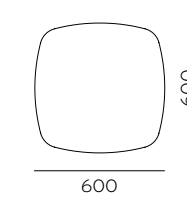
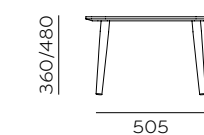

Art. MLT120X74X36

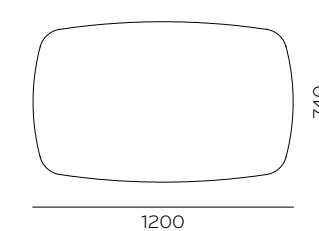
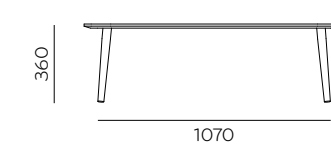

Art. MLT50X50X48

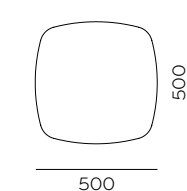
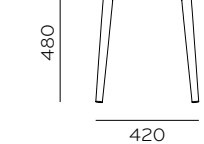

coffee table h 480mm

coffee table h 360mm



COLETTE

ICONIC LIGHT

Alberto Basaglia – Natalia Rota Nodari

"La caratteristica forma iconica rende Colette moderna e vitale, proprio come l'omonima scrittrice francese alla quale ci siamo ispirati. Il diffusore trasparente e lucido che affonda nel corpo lampada goffrato e opalino crea un innovativo gioco di luce che ne evidenzia la natura bicolore".

"The iconic and peculiar design makes Colette contemporary and dynamic, just as the French writer whom we inspired to. The glossy transparent diffuser, together with its textured opaline body, creates an innovative play of light that emphasizes the two-tone colours."



stampata unica in policarbonato
one-piece moulded polycarbonate

finitura lucida
glossy finish

finitura opaca
matt finish

SCHEDA TECNICA

Materiali e tecnologie: policarbonato stampato ad iniezione.
Colori: bianco opalino, trasparente, fumé, giallo, blu e rosso.

TECHNICAL FEATURES

Materials and Technologies: injection moulded polycarbonate.
Colours: opaline white, clear transparent, fumé, yellow, blue and red.

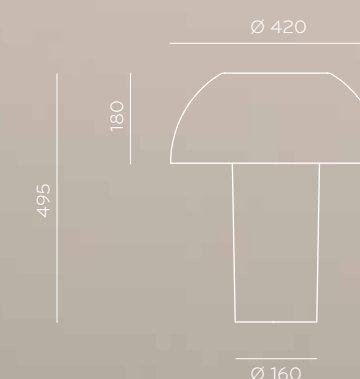

COLETTE 50
Art. LO03TB

FBT 1x20W, 220-240V, E27
IP 20
CE

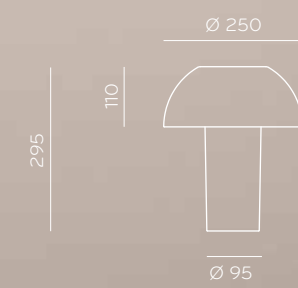

COLETTE
Art. LO03TA

FBT 1x12W, 220-240V, E14
IP 20
CE

BABILA

MEMORY RELOADED

Odo Fioravanti

"Babila si muove con grande agilità tra tradizione e innovazione. Le gambe e le asole dello schienale richiamano le sedie in legno artigianali, per la scocca in multistrato ho voluto sperimentare la tecnica della lavorazione a spessore variabile. Il risultato è una seduta aerea e confortevole, che utilizza il legno solo dove serve".

"Babila moves along tradition and innovation with great agility. The legs and the back eyelets are a reminiscence of the craft wooden chairs, while the plywood shell is obtained by an innovative variable thickness working process. The result is an airy and comfortable seating with a careful use of wood".



scocca in multistrato a spessore variabile
plywood shell in variable thickness



SCHEDA TECNICA

Materie e tecnologie: scocca in multistrato a spessore variabile, gambe in massello di frassino.
Finiture: frassino sbiancato, tinto grigio, tinto nero e tinto giallo.
Varianti: telaio in acciaio a quattro gambe Ø 16mm, a slitta con tondino Ø 10mm.

TECHNICAL FEATURES

Materials and Technologies: plywood shell in variable thickness, solid ash legs.
Finishes: ash wood bleached or stained in grey, black, red, yellow.
Options: four legs frame in steel tube Ø 16mm, or sled frame in steel rod Ø 10mm.

Art. 2710

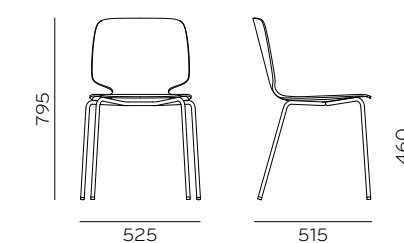

Art. 2700

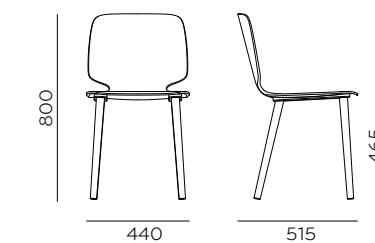

Art. 2720

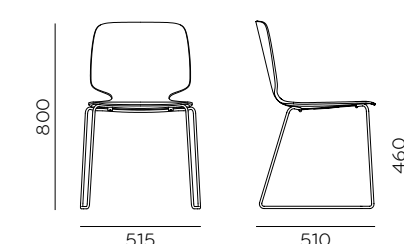

frassino sbiancato
bleached ash wood

"Versatile, caratterizzata da forme semplici e da grande pulizia formale, la famiglia Ikon si arricchisce di una collezione di sedute modulari e di basamenti per tavoli con ripiani dalle dimensioni generose. Adatta sia per interni che per esterni, la collezione nasce dalla ricerca di sintesi, bellezza e funzionalità".

"Defined by simple shapes and clean lines, the versatile Ikon family is now enlarged with a range of modular seating and new table bases that can be equipped with tops in larger sizes. Suitable for indoor and outdoor use, the collection comes from the research of synthesis, beauty and functionality."

Art. 869

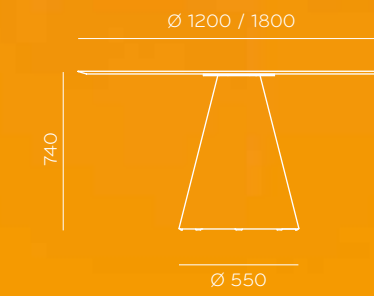

SCHEDA TECNICA

Materiali e tecnologie: base grande in polietilene stampaggio rotazionale, da zavorrare.
Ripiano in laminato o in mdf laccato sp 30mm, misura massima Ø 1800mm.
Colori: bianco, nero, grigio chiaro e sabbia.

TECHNICAL FEATURES

Materials and Technologies: rotomoulded polyethylene base, to be filled.
Laminate or mdf lacquered top thickness 30 mm.
Colours: white, black, light grey and beige.



IKON bench



seduta in stratificato
solid laminate seat

Art. B863_1C

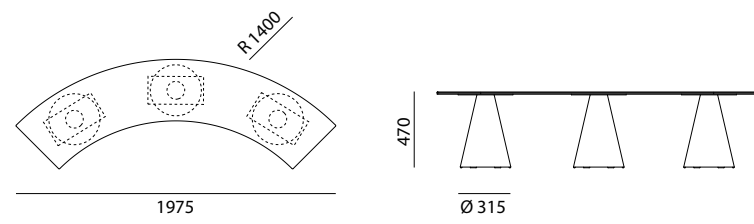

Alcune possibili configurazioni Some possible combinations

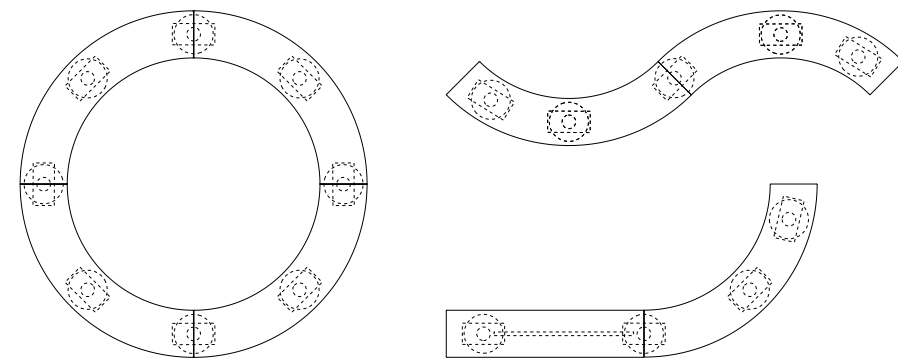

Art. B863_1L

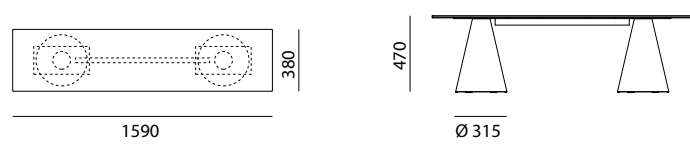

SCHEDA TECNICA

Materiali e tecnologie: base in polipropilene stampato ad iniezione, seduta in compact spessore 12mm.
Colori: bianco, nero, grigio chiaro e sabbia.

TECHNICAL FEATURES

Materials and Technologies: injected moulded polypropylene base, solid laminate seat thickness 12mm.
Colours: white, black, light grey and beige.

base in polipropilene stampata a iniezione
injected polypropylene base



modulare
modular

SALEWA HEAD- QUARTER BOLZANO

Cino Zucchi Architetti / Park Associati

"Per il tetto verde ed il ristorante aziendale erano necessari sedute e tavoli funzionali che esprimessero il 'mood sportivo' del marchio. La sedia Mya accostata alle forme squadrate ed essenziali del tavolo Togo è risultata la soluzione più efficace".

"For the green roof and the company restaurant we needed functional seats and tables able to convey the 'sportive mood' of the brand. Mya chair, combined with the squared and essential shape of Togo table, had been indeed the more effective solution".

HEADQUARTER DA VIVERE HEADQUARTER TO LIVE

Salewa è un marchio leader per l'attrezzatura e l'abbigliamento da montagna.

La sua idea era creare, all'interno del proprio headquarter, la palestra di roccia più grande d'Italia aperta al pubblico, con l'obiettivo di offrire nuove opportunità di comunicazione tra le persone.

Salewa is a leader brand in mountain equipments. Its idea was to create the biggest rock climbing wall in Italy opened to public, with the aim of creating new communication opportunities between people.

SCHEDA PROGETTO PROJECT OUTLINE

Luogo / Location: **Bolzano**
 Data di completamento / Date of Completion: ottobre 2011 / **October 2011**
 Destinazione d'uso / Principal Use: headquarter Salewa e spazio pubblico / **Salewa headquarter and public space**
 Struttura / Structure: pareti rivestite in pannelli di zinco al titanio; rivestimento a maglia forata / **walls covered by panels in zinc-coated titanium; external perforated mash paneling**
 Dimensione area / Site area: **30.595 m²**
 Volume costruito / Building volume: **146.248 m³**

PEDRALI MIRROR

Migliore + Servetto Architects

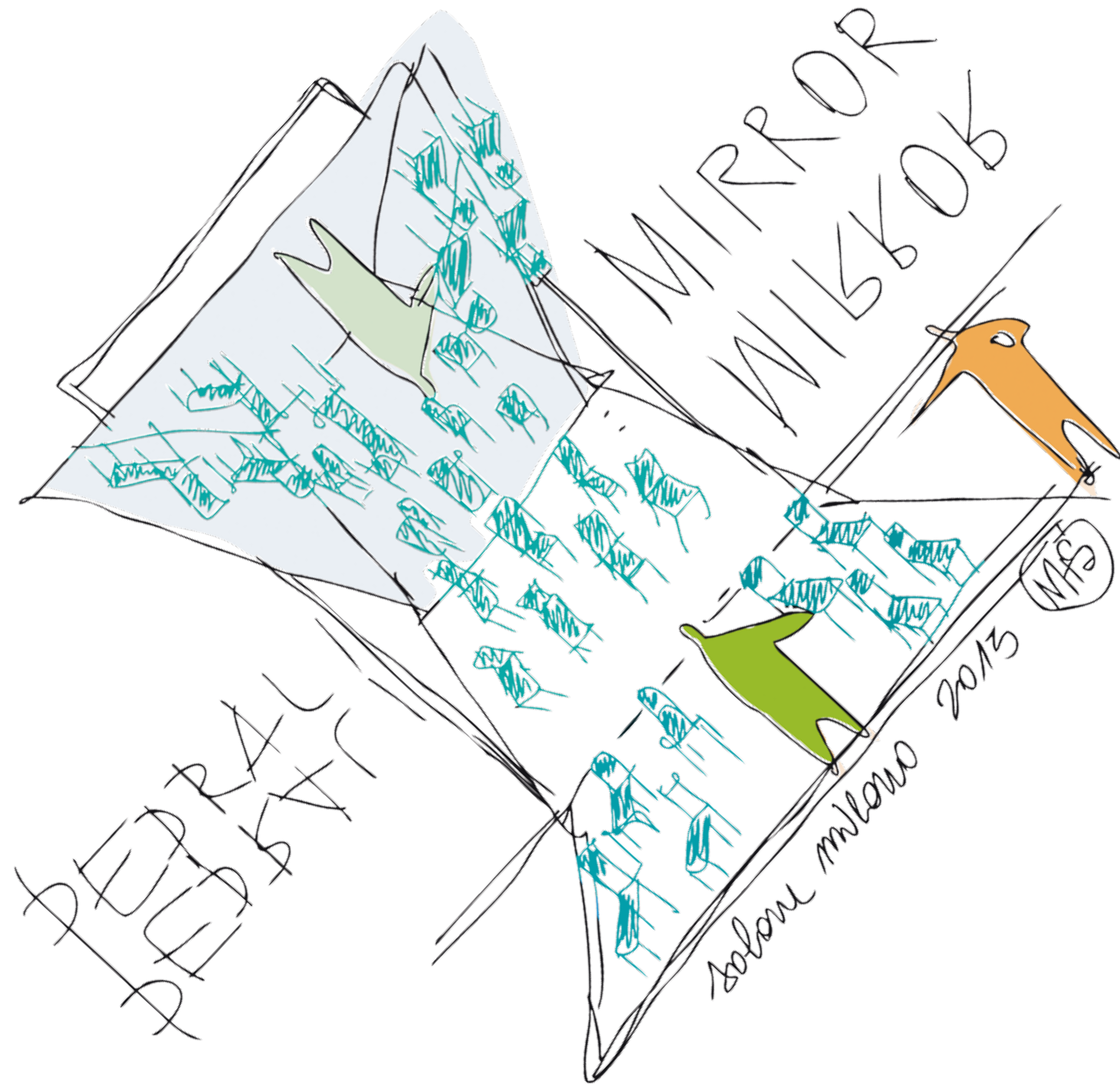

"Pedrali Mirror è una piazza sopraelevata di incontro da cui si sviluppa una 'promenade' tra i prodotti e le novità 2013. Ai lati della camminata, porzioni della pavimentazione si sollevano come carta di un origami e si ripiegano in angolazioni atipiche, mentre le superfici a specchio danno allo spazio una nuova dimensione".

"La scelta di campire di un giallo intenso le superfici esterne della pavimentazione contribuisce a creare un senso maggiore di contrapposizione tra interno ed esterno, descrivendo una sorta di perimetro cromatico".

"Pedrali Mirror is a meetings plaza where you can walk among products and novelties 2013. Along the sides of this 'promenade', portions of paving arise as an origami paper, folding up in unusual angles, whilst the mirrored surfaces give to the space a new dimension".

"The deep yellow choice for the outer flooring surface helps to create a greater sense of contrast between inside and outside, designing a sort of chromatic perimeter".

I NOSTRI ULTIMI SUCCESSI

A WHEEL FOR PEDRALI

Migliore + Servetto Architects



MALMÖ

M.Cazzaniga - S.Mandelli - A.Pagliarulo



reddot design award winner 2013

ARA

Jorge Pensi Design Studio



reddot design award winner 2013

NOA

Marc Sadler



reddot design award winner 2013



PEDRALI SpA

SP 122
Mornico al Serio 24050
Bergamo
Italy

www.pedrali.it
info@pedrali.it

Export Dept.

t. +39 035 8358840
f. +39 035 8358888

Ufficio Commerciale Italia

t. +39 035 8358810
f. +39 035 8358888

PEDRALI®